

# Voxel Models

Mobile Brochure Edition

[www.voxel-co.com](http://www.voxel-co.com)



v o x e l

The pleasant sense of difference

# Steria model

Dimensions : 60\*60\*4 cm

Material : GFRG (Interior)

Weight : 24 kg (Per square meter)

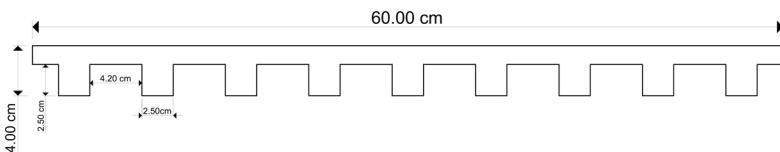
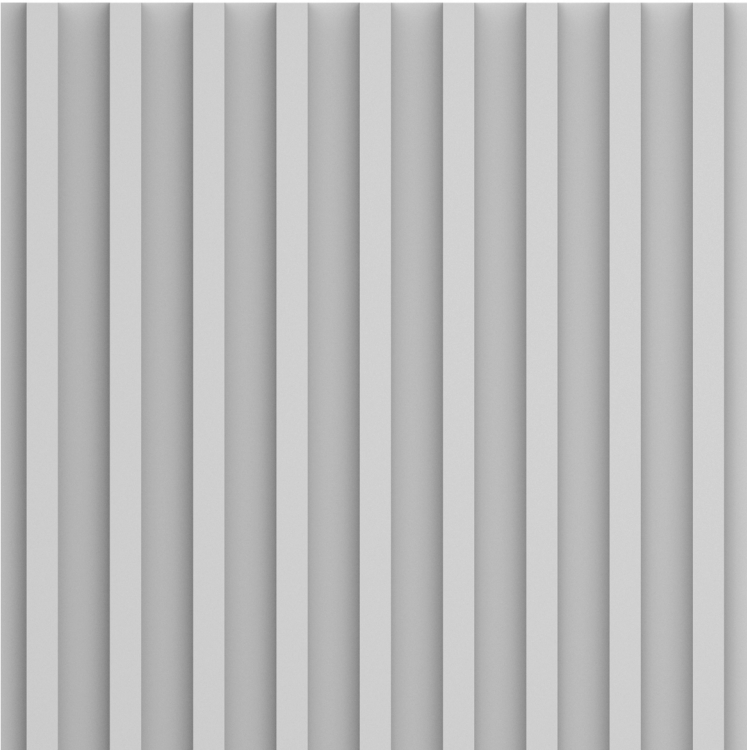

[www.voxel-co.com](http://www.voxel-co.com)



v o x e l

The pleasant sense of difference

# Steria<sup>MAX</sup> model

Dimensions : 60\*60\*5.2 cm

Material : GFRG (Interior)

Weight : 25 kg (Per square meter)

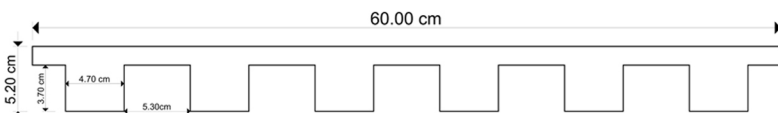
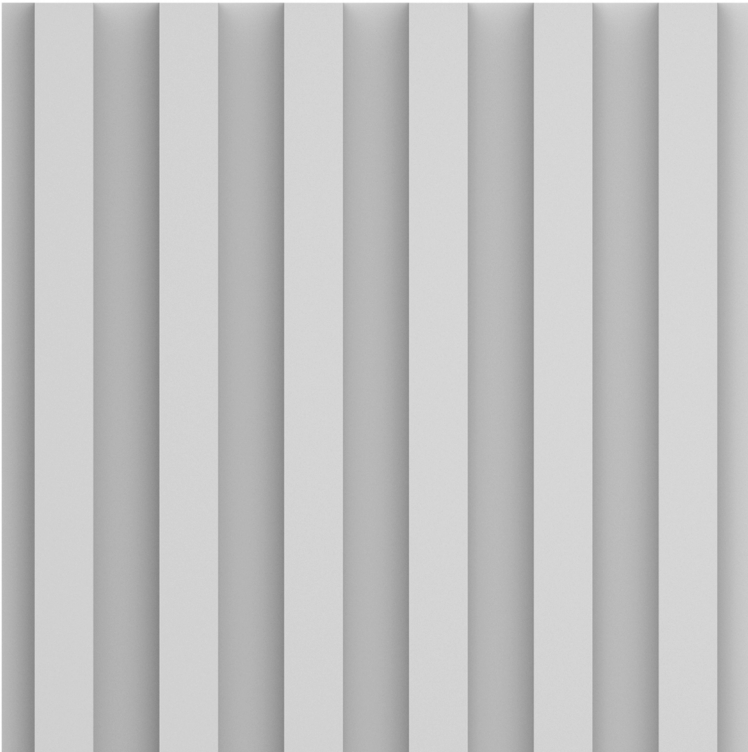

[www.voxel-co.com](http://www.voxel-co.com)



v o x e l

The pleasant sense of difference

# Steria<sup>x2</sup> model

Dimensions : 60\*60\*4 cm

Material : GFRG (Interior)

Weight : 24 kg (Per square meter)

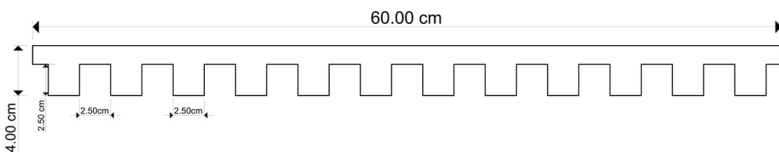
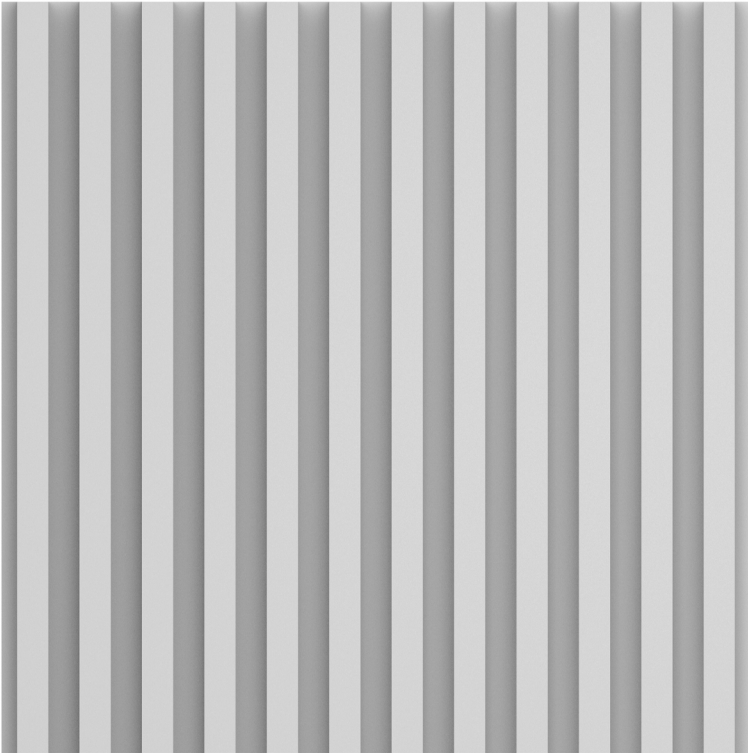

[www.voxel-co.com](http://www.voxel-co.com)



v o x e l

The pleasant sense of difference

# Steria <sup>PARA</sup> model

Dimensions : 60\*60\*3.2 cm

Material : GFRG (Interior)

Weight : 24 kg (Per square meter)

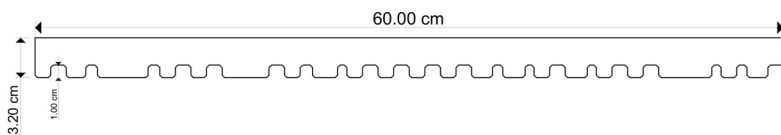
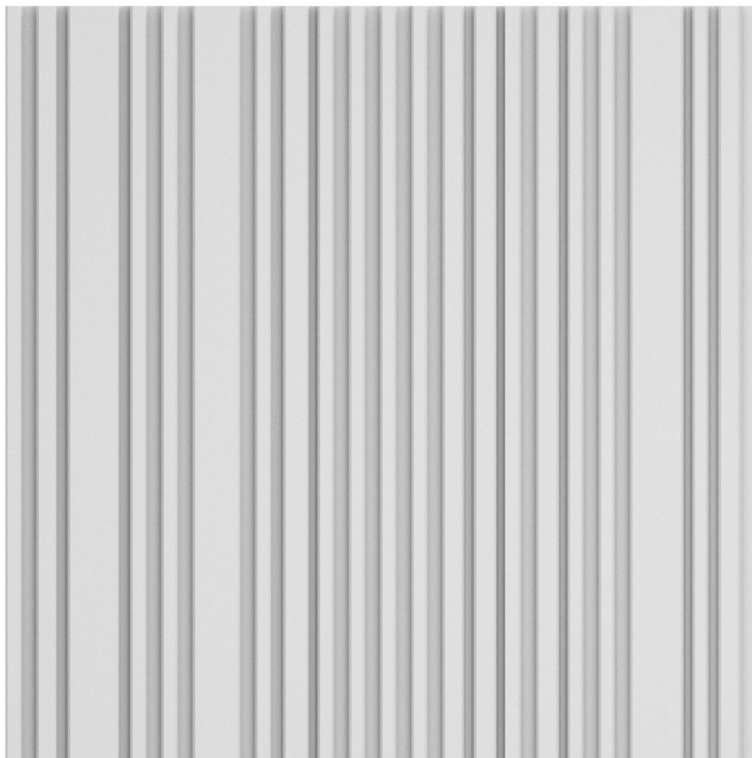

[www.voxel-co.com](http://www.voxel-co.com)



v o x e l

The pleasant sense of difference

# Ripple model

Dimensions : 60\*60\*3.5 cm

Material : GFRG (Interior)

Weight : 24 kg (Per square meter)

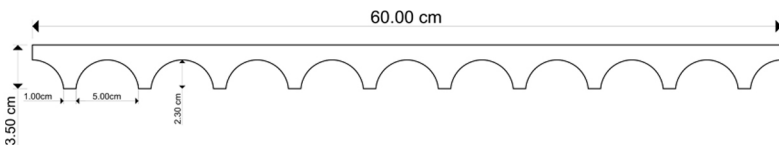
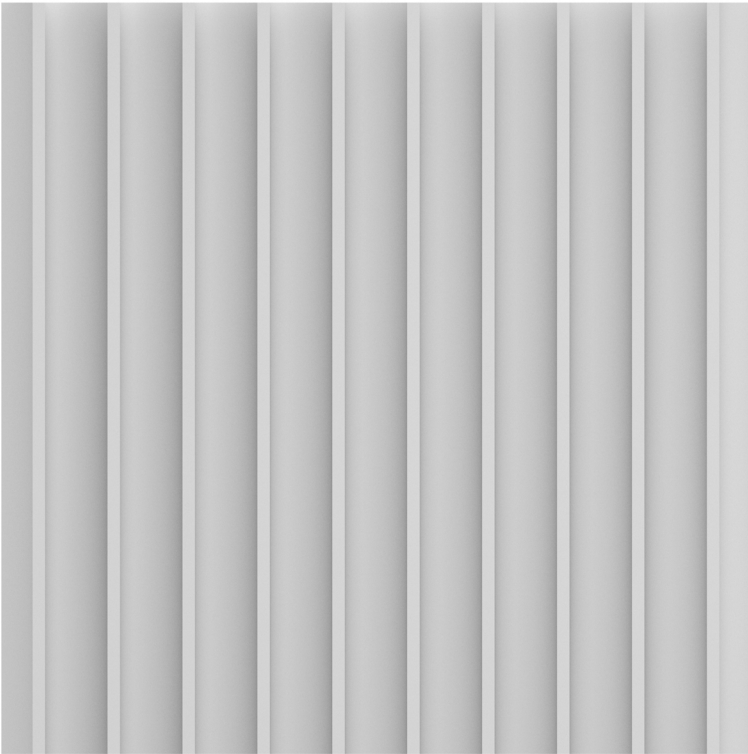

[www.voxel-co.com](http://www.voxel-co.com)



v o x e l

The pleasant sense of difference

# Ripple<sup>MAX</sup> model

Dimensions : 60\*60\*3.5 cm

Material : GFRG (Interior)

Weight : 24 kg (Per square meter)

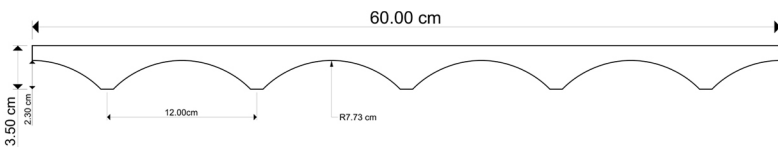



v o x e l

The pleasant sense of difference

# Pyramid model

Dimensions : 60\*60\*5 cm

Material : GFRG (Interior)

Weight : 24 kg (Per square meter)

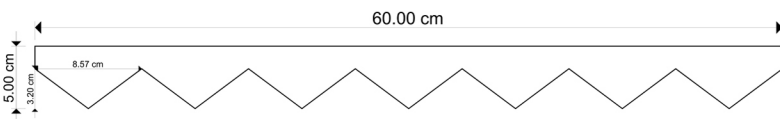
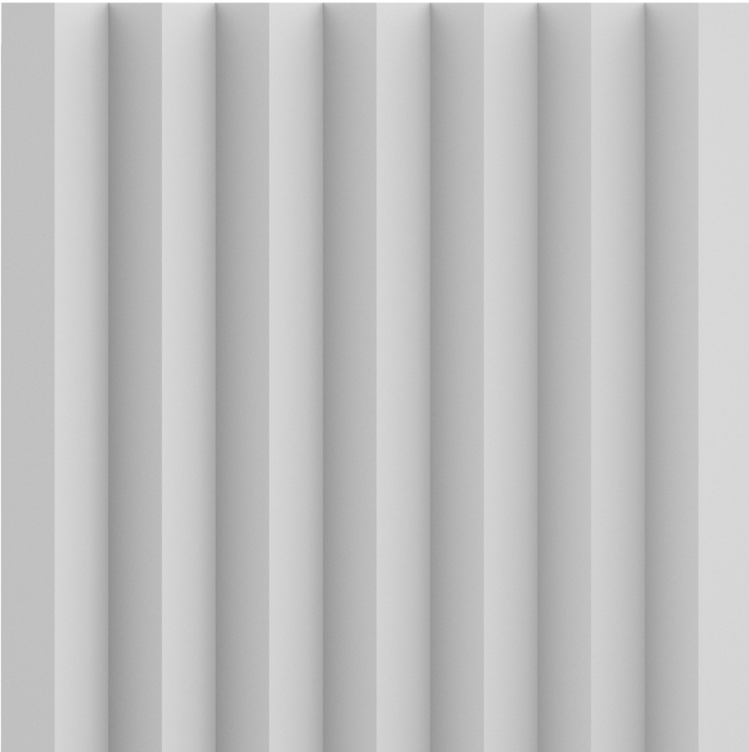





v o x e l

The pleasant sense of difference

# Pyramid<sup>x</sup> model

Dimensions : 8.57\*60\*5 cm

Material : GFRG (Interior)

Weight : 24 kg (Per square meter)

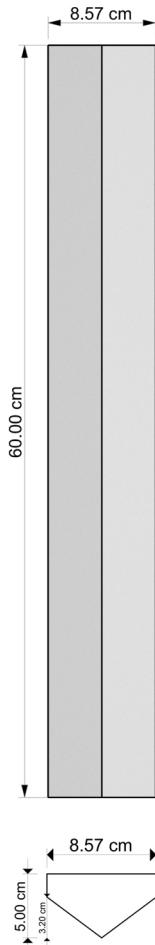



v o x e l

The pleasant sense of difference

# Pyramid<sup>x2</sup> model

Dimensions : 60\*60\*3.8 cm

Material : GFRG (Interior)

Weight : 24 kg (Per square meter)

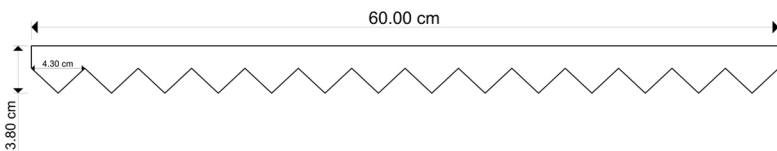
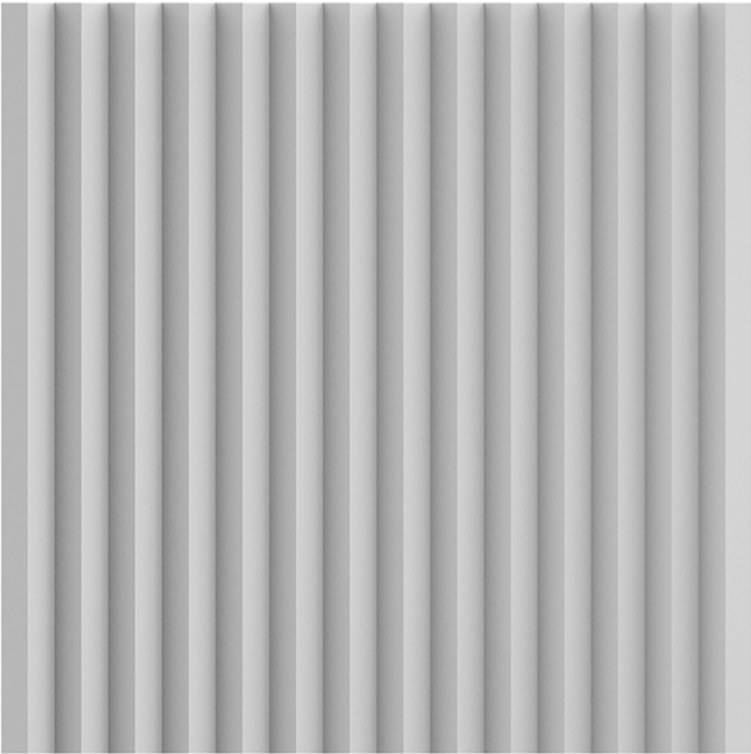

[www.voxel-co.com](http://www.voxel-co.com)



v o x e l

The pleasant sense of difference

# Pyramid<sup>Para</sup> model

Dimensions : 8.57\*60\*5 cm (14 Types )

Material : GFRG (Interior)

Weight : 24 kg (Per square meter)

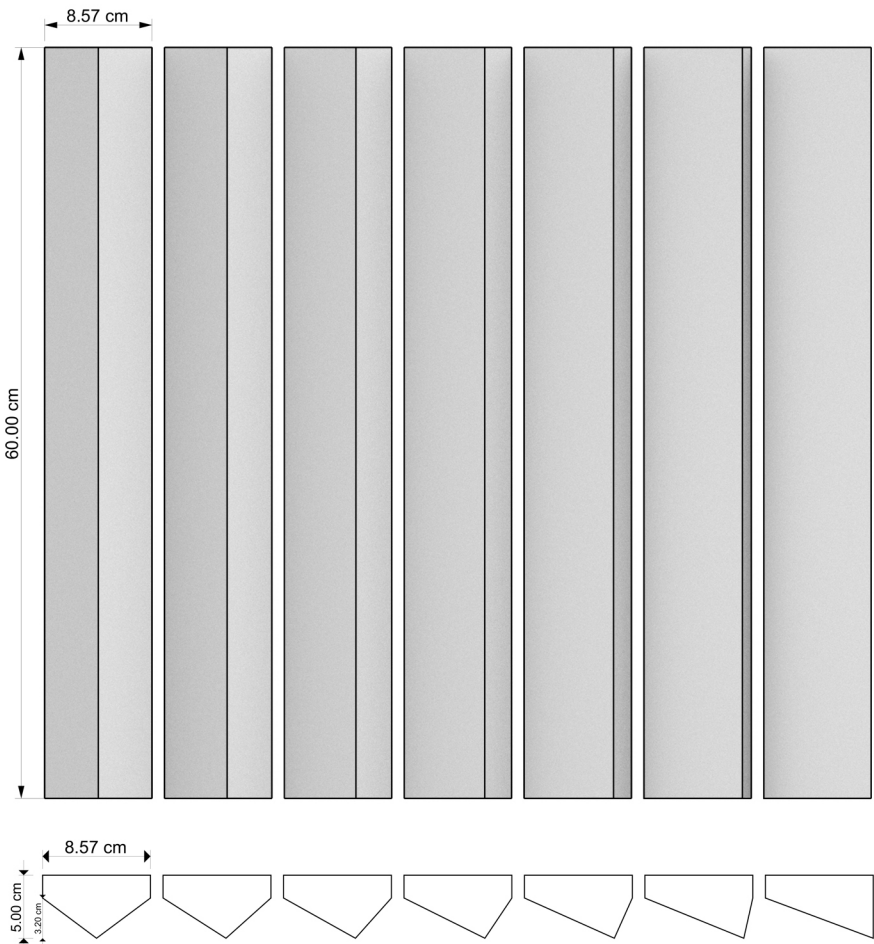



v o x e l

The pleasant sense of difference

# Smooth model

Dimensions : 60\*60\*4 cm

Material : GFRG (Interior)

Weight : 25 kg (Per square meter)

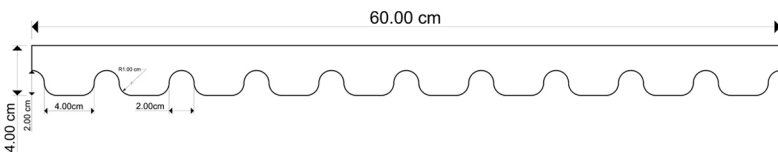
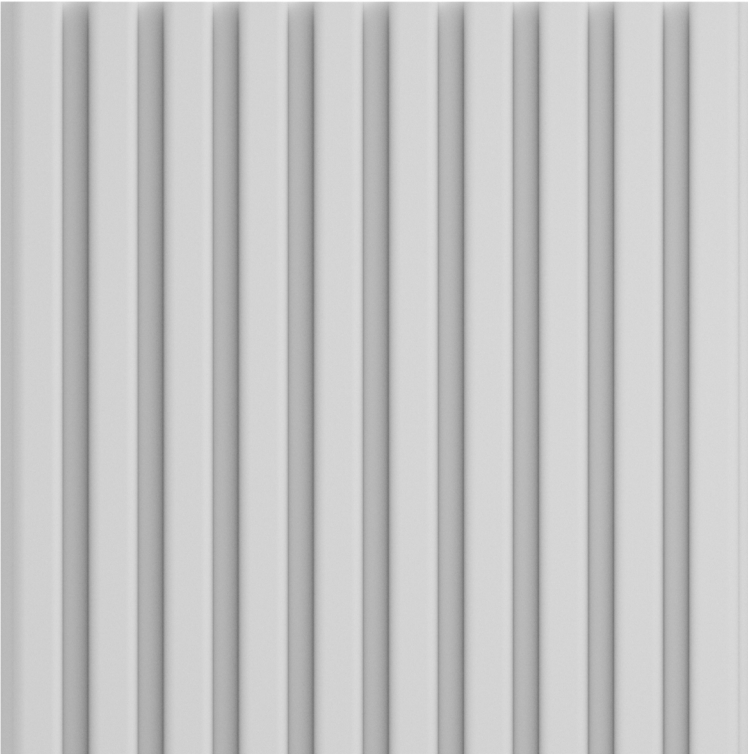

[www.voxel-co.com](http://www.voxel-co.com)



v o x e l

The pleasant sense of difference

# Smooth<sup>x2</sup> model

Dimensions : 60\*60\*3.6 cm

Material : GFRG (Interior)

Weight : 24 kg (Per square meter)

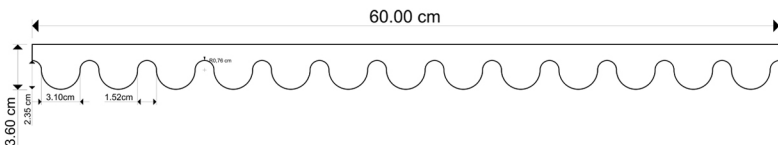
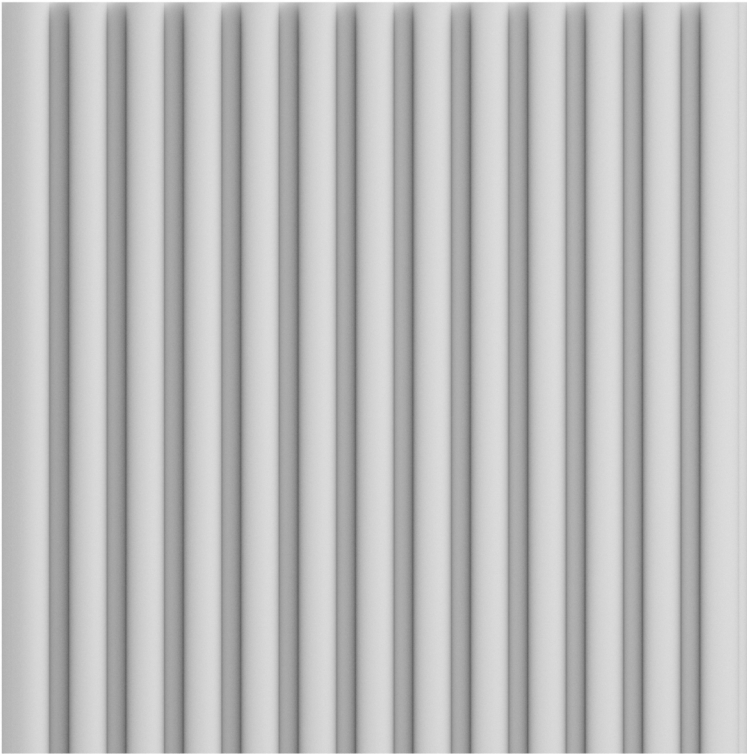

[www.voxel-co.com](http://www.voxel-co.com)



v o x e l

The pleasant sense of difference

# Billow model

Dimensions : 60\*60\*2.5 cm

Material : GFRG (Interior)

Weight : 25 kg (Per square meter)

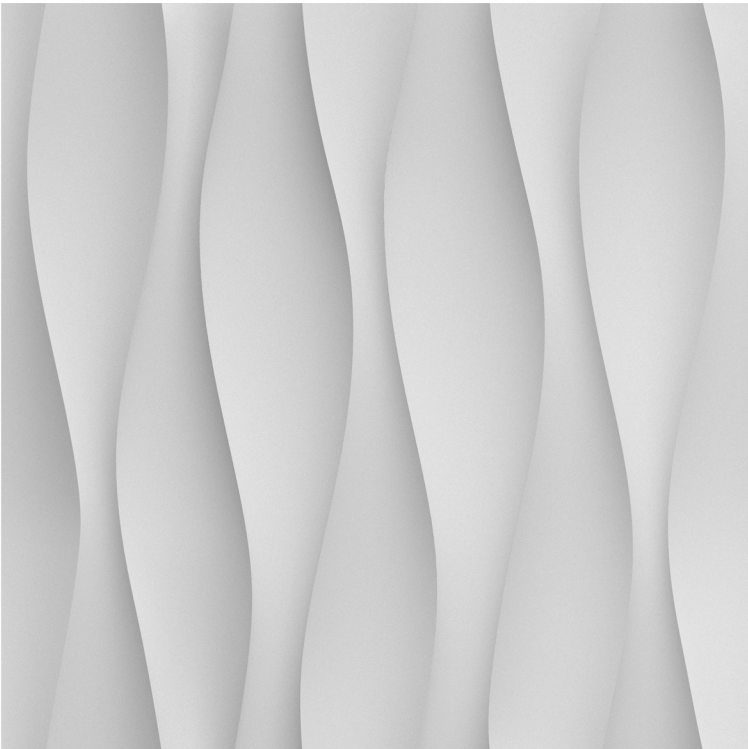



v o x e l

The pleasant sense of difference

# Blande model

Dimensions : 60\*60\*2.5 cm

Material : GFRG (Interior)

Weight : 27 kg (Per square meter)

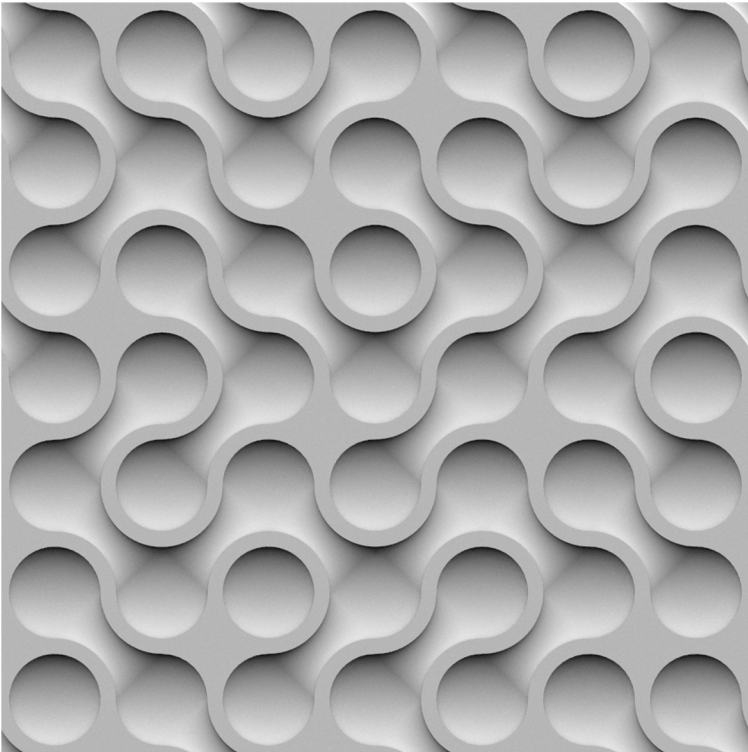



v o x e l

The pleasant sense of difference

# Lepido model

Dimensions : 60\*60\*2.5 cm

Material : GFRG (Interior)

Weight : 25 kg (Per square meter)

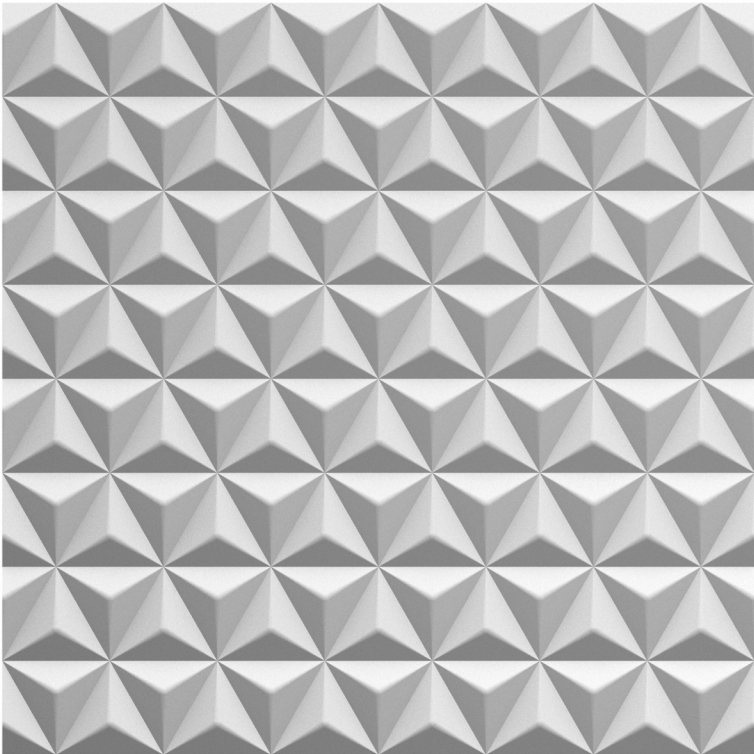





v o x e l

The pleasant sense of difference

# Lotus model

Dimensions : 60\*60\*2.5 cm

Material : GFRG (Interior)

Weight : 25 kg (Per square meter)

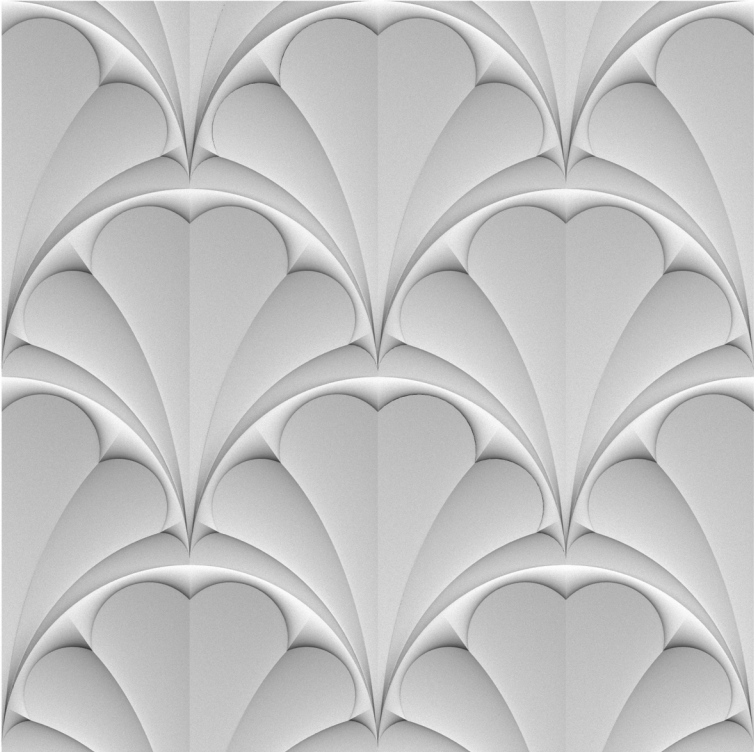



v o x e l

The pleasant sense of difference

# Floria model

Dimensions : 60\*60\*2.5 cm

Material : GFRG (Interior)

Weight : 25 kg (Per square meter)





v o x e l

The pleasant sense of difference

# Islamic model

Dimensions : 60\*60\*3.2 cm

Material : GFRG (Interior)

Weight : 22 kg (Per square meter)

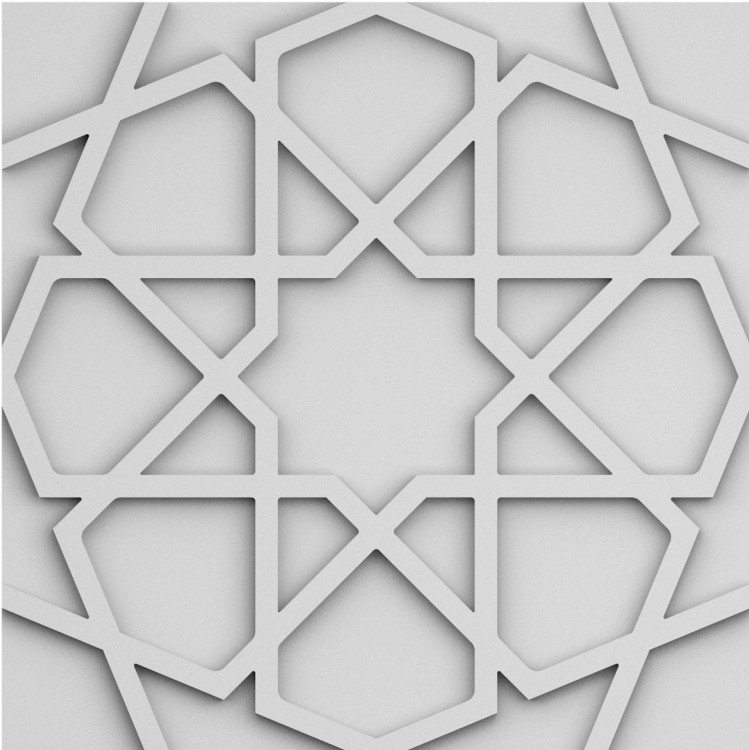



v o x e l

The pleasant sense of difference

# Cube model

Dimensions : 2 Types tile

Material : GFRG (Interior)

Weight : 20 kg (Per square meter)

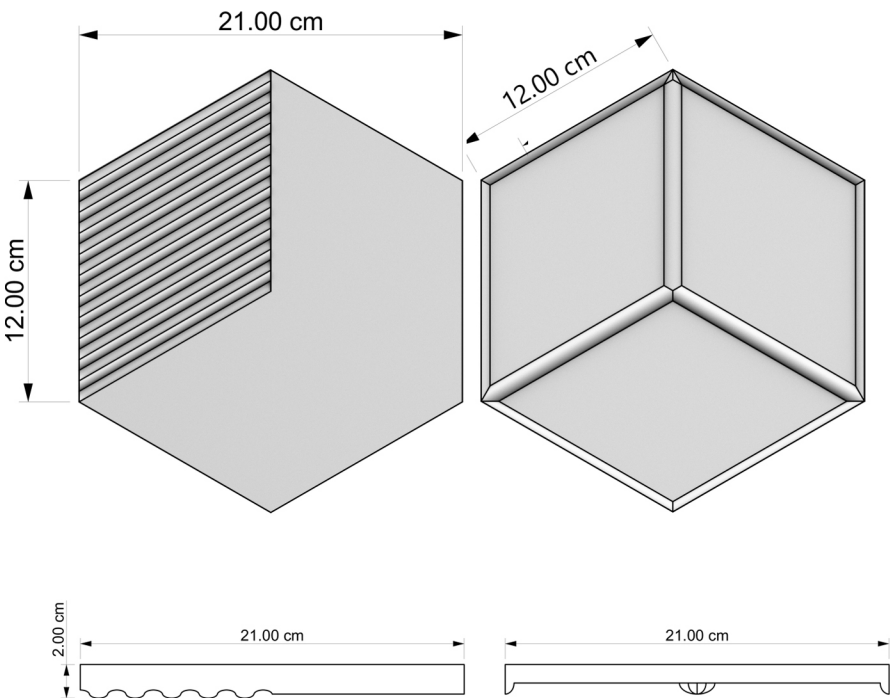



voxel

The pleasant sense of difference

# Diamond model

Dimensions : 30\*60\*4.0 cm

Material : GFRG (Interior)

Weight : 24 kg (Per square meter)

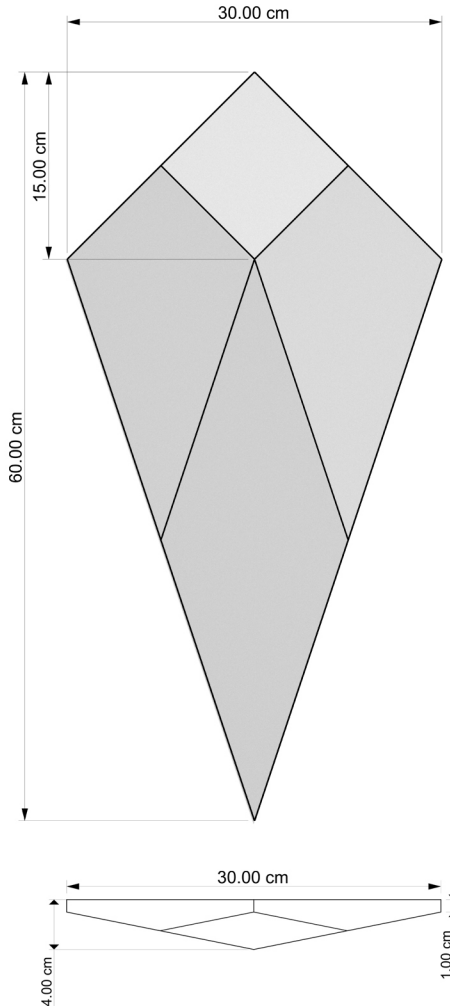



voxel

The pleasant sense of difference

## Rhombus model

Dimensions : 30\*60\*2.5 cm

Material : GFRG (Interior)

Weight : 21 kg (Per square meter)

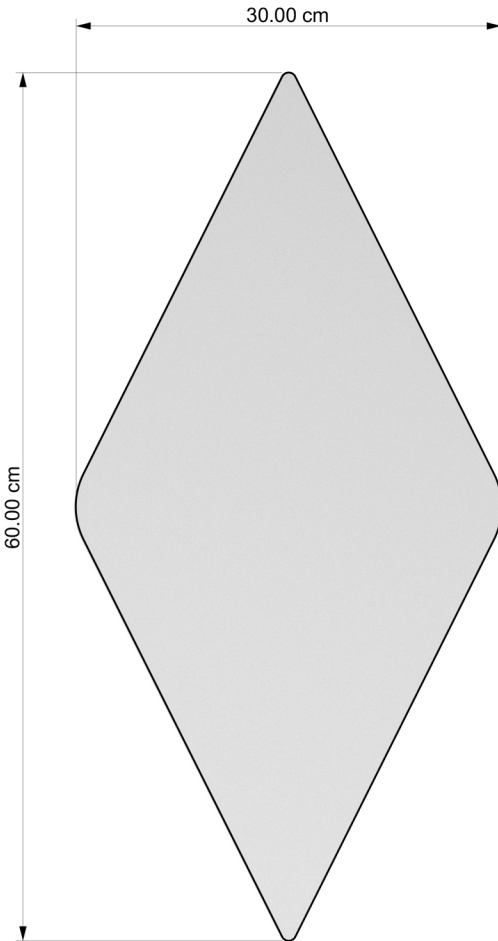



voxel

The pleasant sense of difference

## Venom model

Dimensions : 20\*30\*4.0 cm

Material : GFRG (Interior)

Weight : 21 kg (Per square meter)

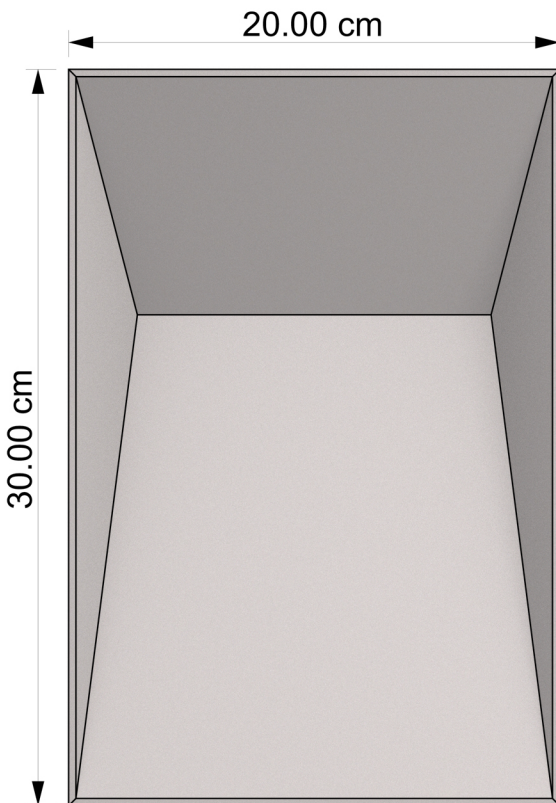



v o x e l

The pleasant sense of difference

# Vitra model

Dimensions : ( 10 Types Tile )

Material : GFRG (Interior)

Weight : 15 kg (Per square meter)

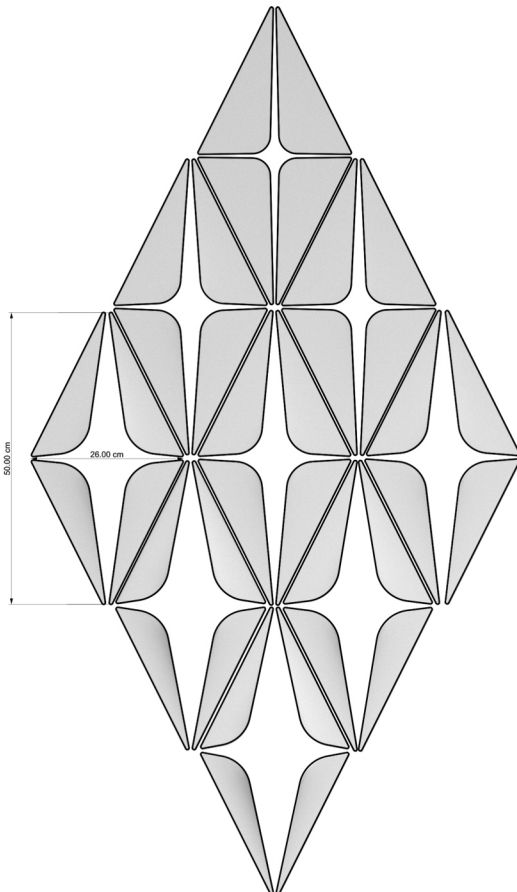





voxel

The pleasant sense of difference

# Delta model

Dimensions : 10 Types Tile

Material : GFRG (Interior)

Weight : 24 kg (Per square meter)

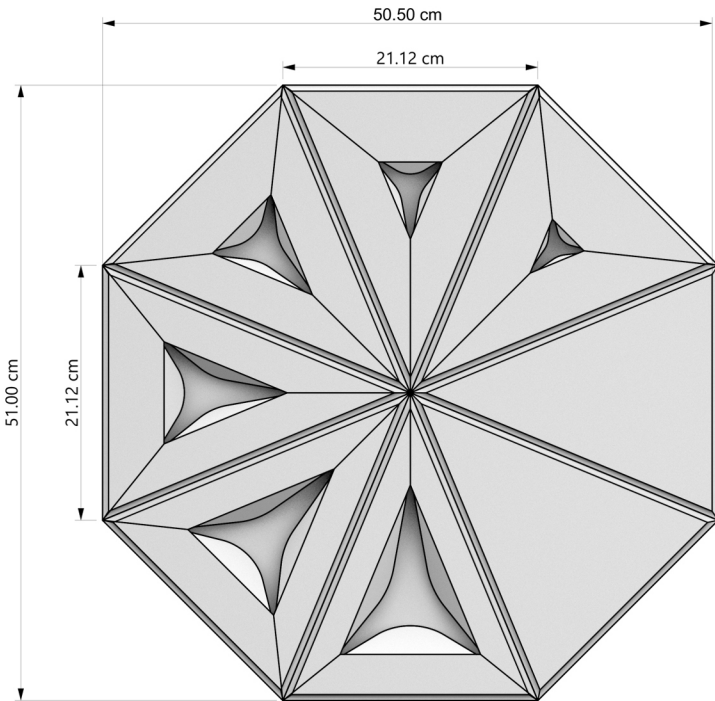



voxel

The pleasant sense of difference

# Vertex model

Dimensions : ( 7 Types Tile )

Material : GFRG (Interior)

Weight : 25 kg (Per square meter)

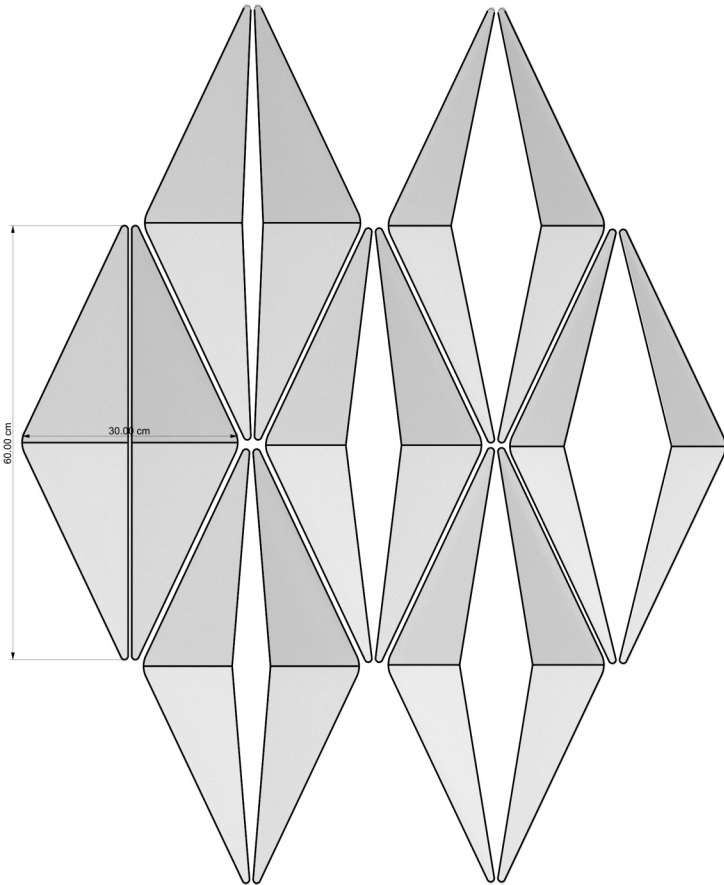



voxel

The pleasant sense of difference

# Tempus model

Dimensions : 60\*120\*3.80 cm

Material : GFRC (Exterior)

Weight : 60 kg (Per square meter)

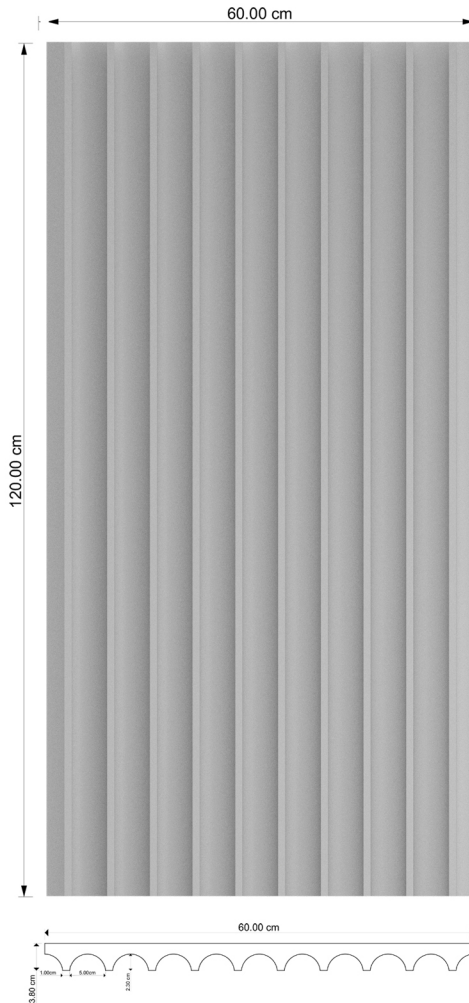

[www.voxel-co.com](http://www.voxel-co.com)



v o x e l

The pleasant sense of difference

## Palameds model

Dimensions : 60\*120\*4.90 cm

Material : GFRC (Exterior)

Weight : 60 kg (Per square meter)

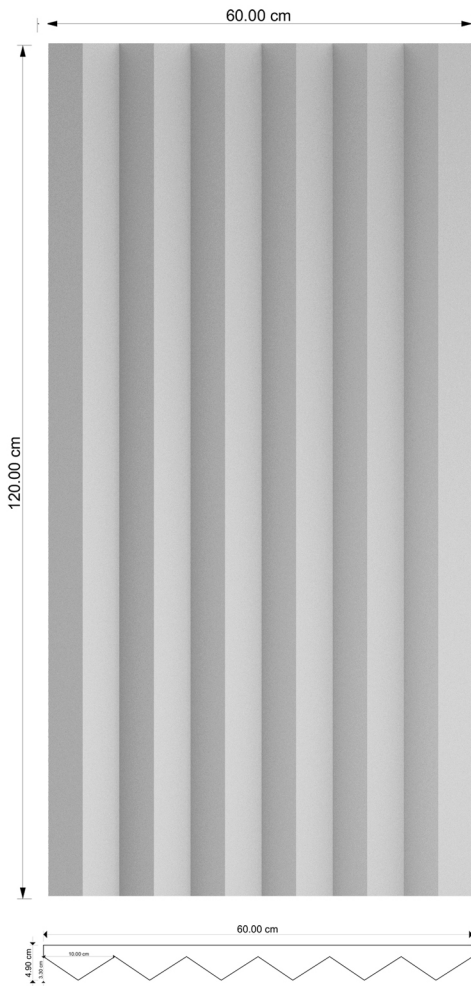

[www.voxel-co.com](http://www.voxel-co.com)



v o x e l

The pleasant sense of difference

## Ribbed model

Dimensions : 60\*150\*3.80 cm (3 Types panel )

Material : GFRC (Extetior)

Weight : 60 kg (Per square meter)

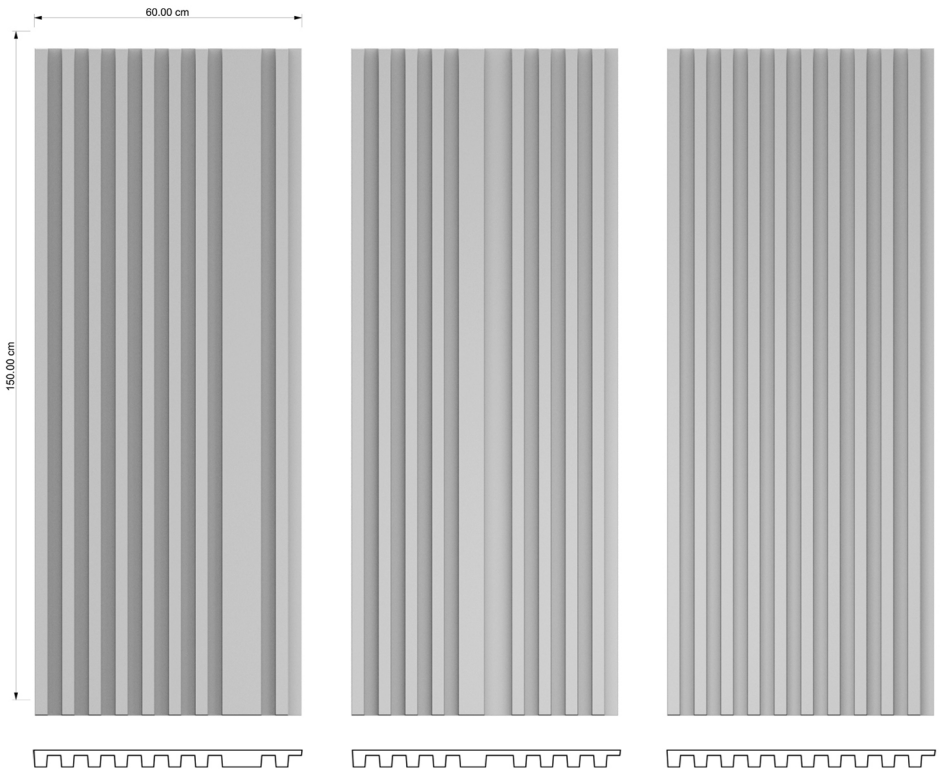



v o x e l

The pleasant sense of difference

# Expose model

Dimensions : 60\*120\*3.0 cm

Material : GFRC (Exterior)

Weight : 60 kg (Per square meter)

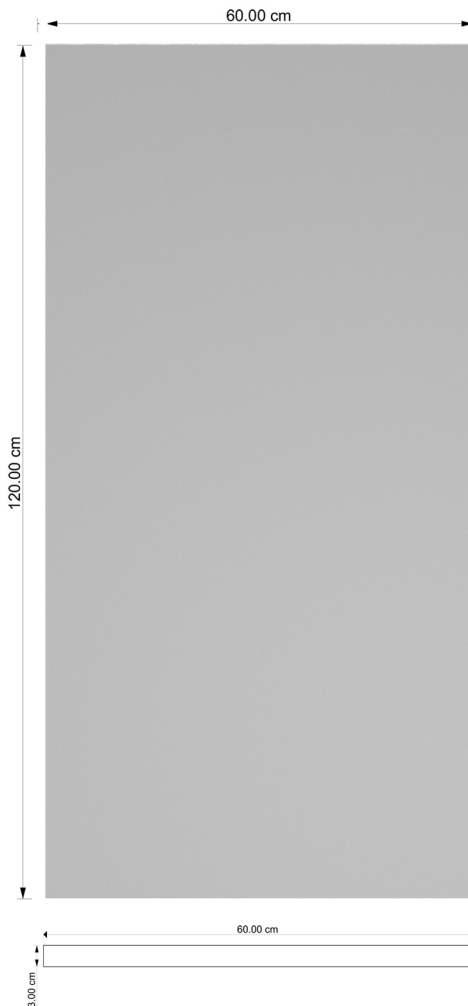

[www.voxel-co.com](http://www.voxel-co.com)



v o x e l

The pleasant sense of difference

# Expose <sup>BOLT</sup> model

Dimensions : 60\*120\*3.0 cm

Material : GFRC (Exterior)

Weight : 60 kg (Per square meter)

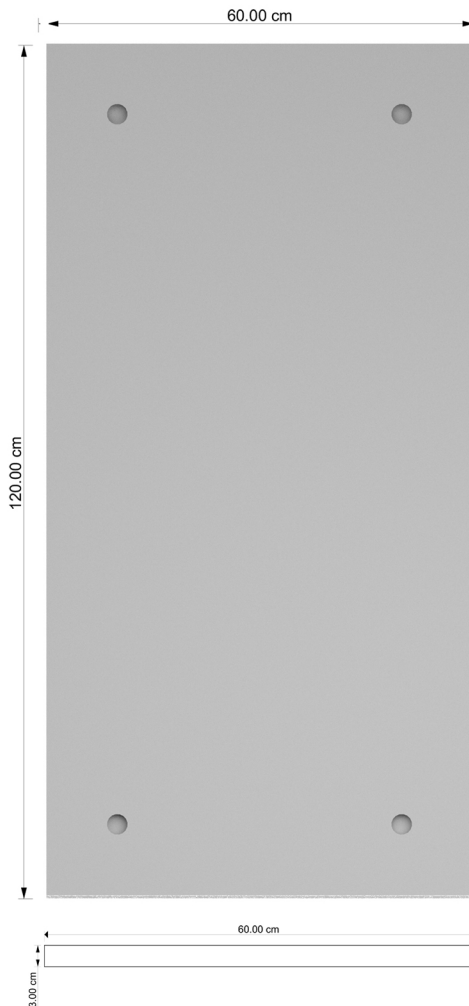

[www.voxel-co.com](http://www.voxel-co.com)



v o x e l

The pleasant sense of difference

# Expose model

Dimensions : 60\*30\*3.0 cm

Material : GFRC (Exterior)

Weight : 60 kg (Per square meter)

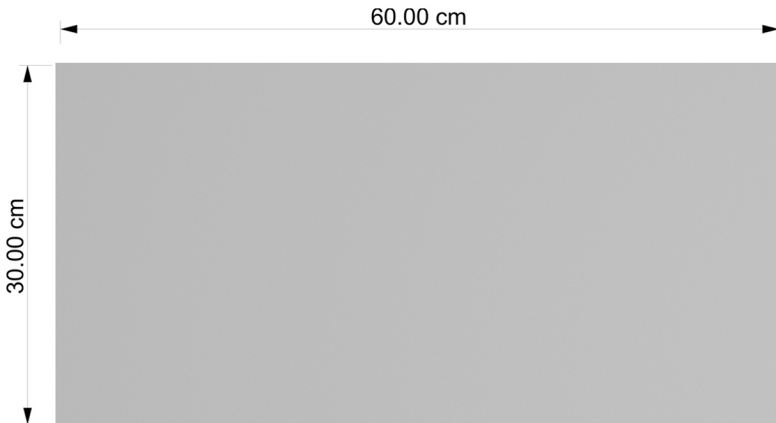





v o x e l

The pleasant sense of difference

# Expose <sup>Flooring</sup> model

Dimensions : 100\*100\*4.0 cm

Material : GFRC (Exterior)

Weight : 80 kg (Per square meter)

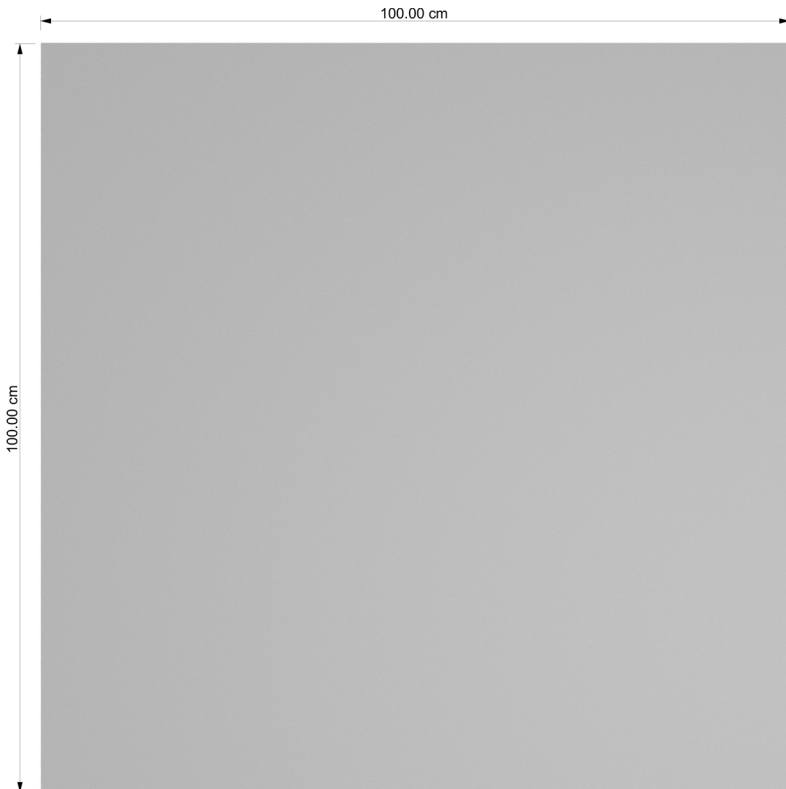



v o x e l

The pleasant sense of difference

# Pixel model

Dimensions : 60\*150\*

Material : GFRC (Exterior)

Weight : 60 kg (Per square meter)

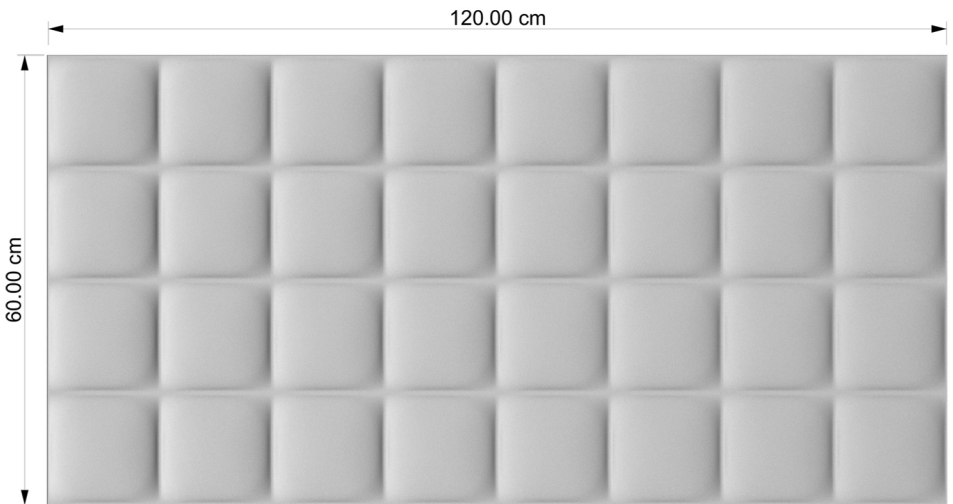



v o x e l

The pleasant sense of difference

# Manta model

Dimensions : 64\*156\*5 cm ( 2 Types panel )

Material : GFRC (Extetior)

Weight : 60 kg (Per sqare meter)

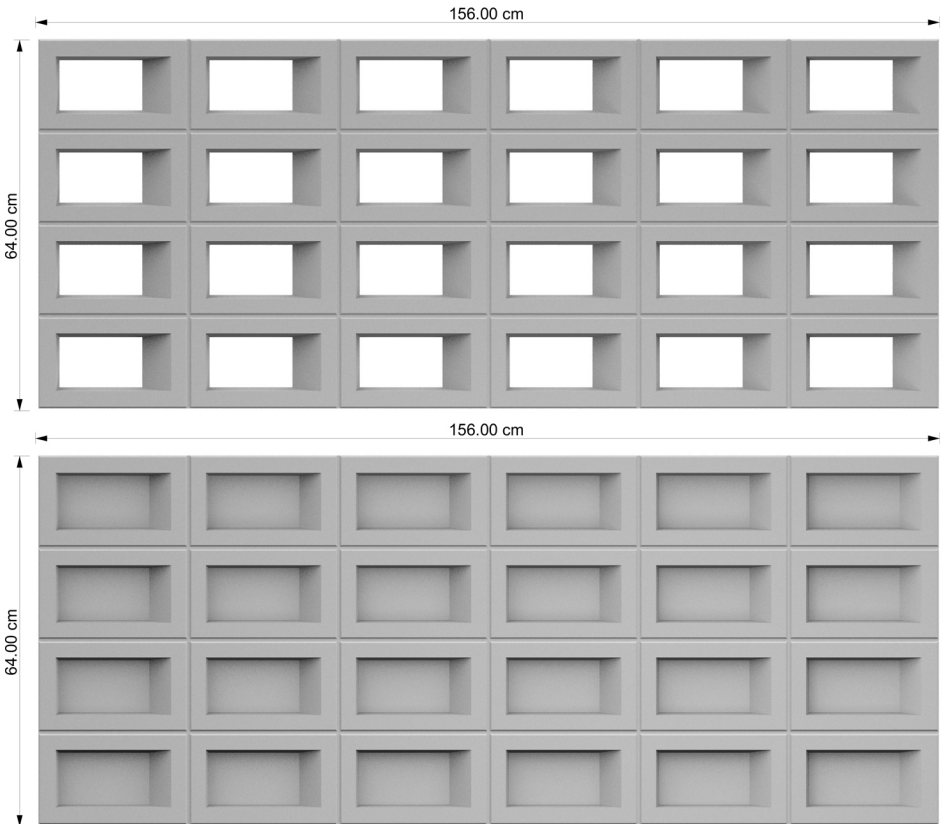



v o x e l

The pleasant sense of difference

## Vondom model

Dimensions : ( 5 Types Tiles )

Material : GFRC (Extetior)

Weight : 55 kg (Per sqare meter)

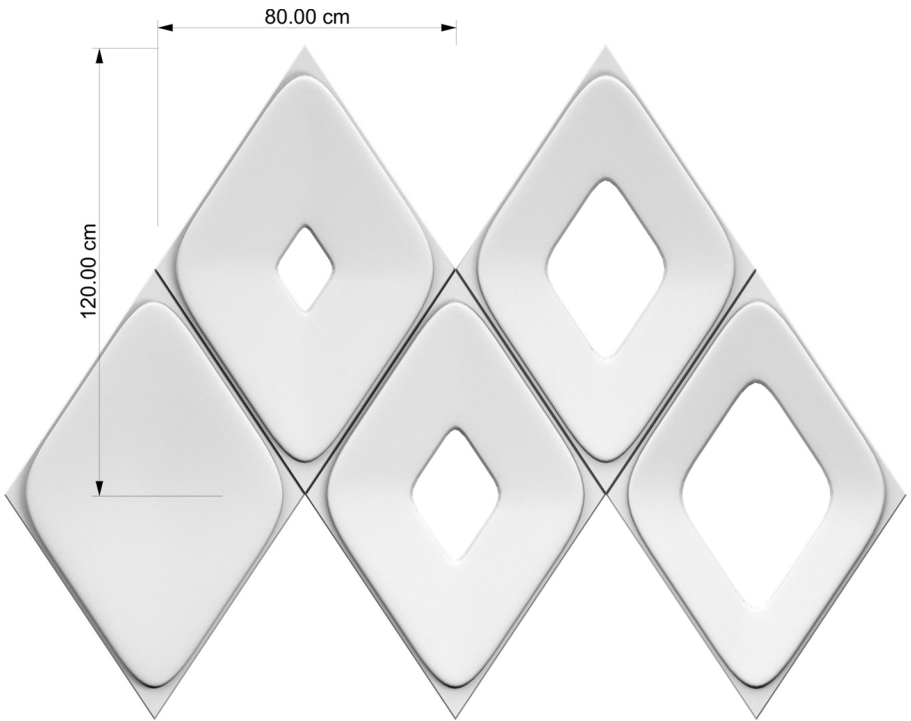



v o x e l

The pleasant sense of difference

# Prism model

Dimensions : 90\*30\*2.25 cm

Material : GFRC (Exterior)

Weight : 60 kg (Per square meter)

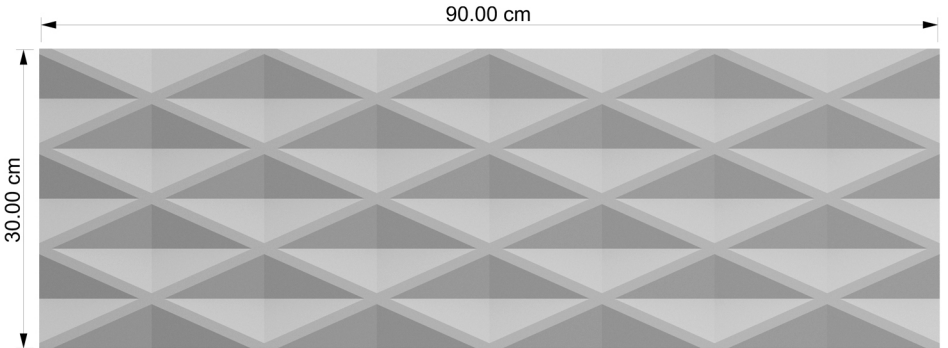

## Showroom

---



Unit 15, No 7, Marvdasht Street, Ashrafi Esfahani  
Expressway, Tehran

---

## Sales

---



021-442 641 94

---



+98 912 610 33 80

---